

Modeling a simple twisted wire

CARRERA 8.5
pro

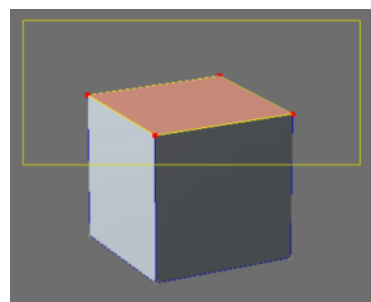

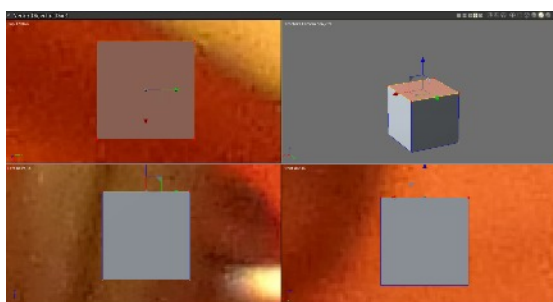

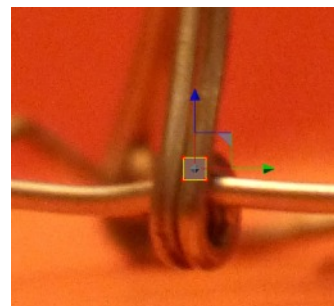
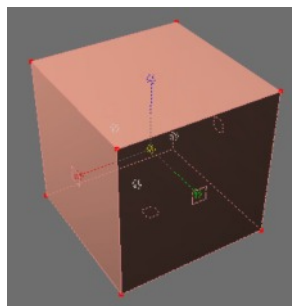
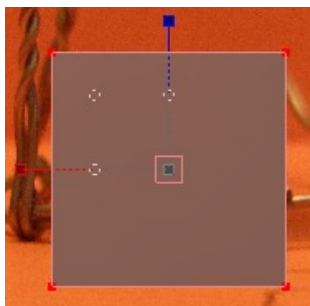
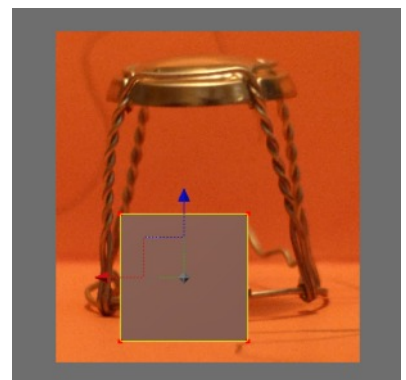
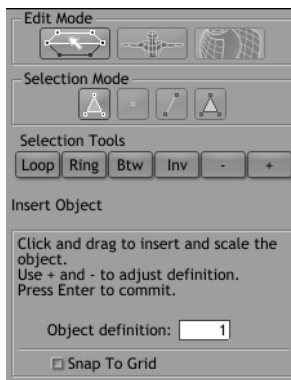
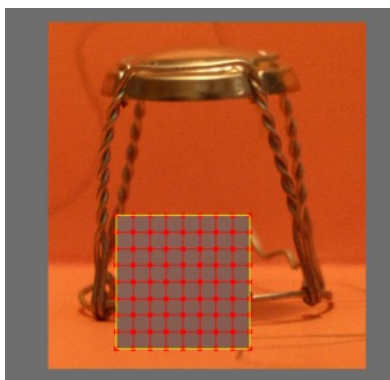
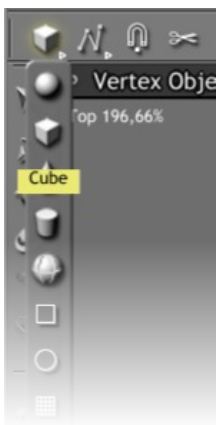
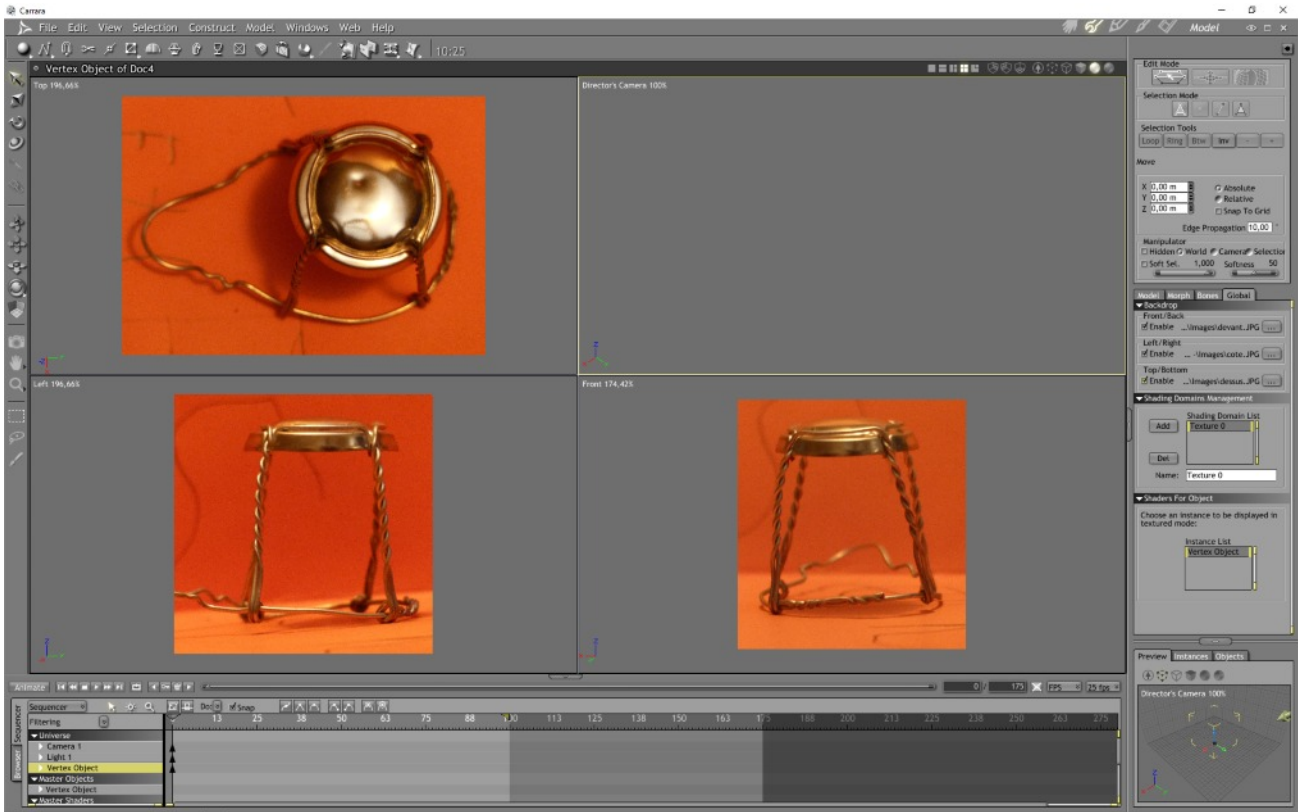
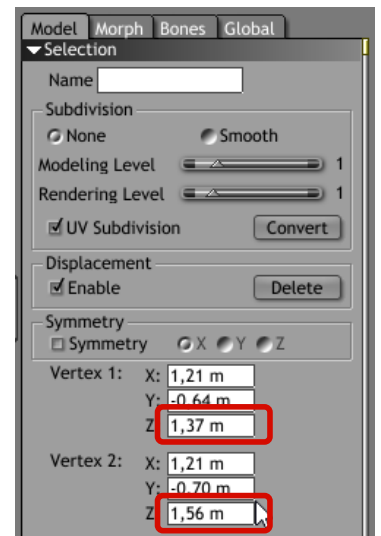
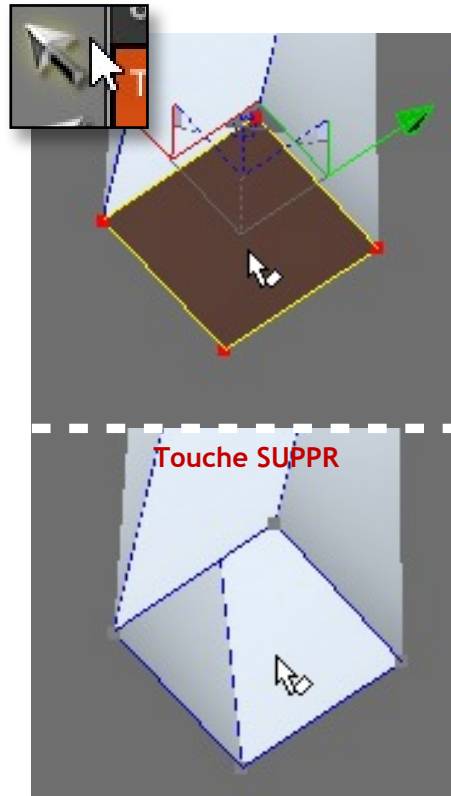
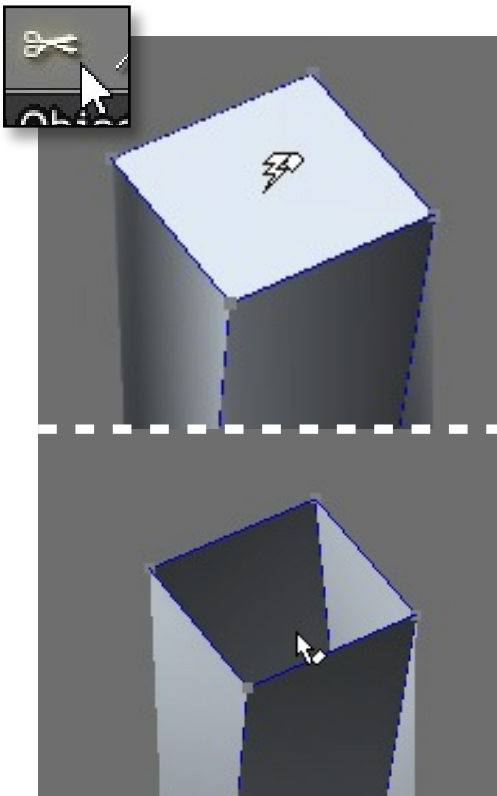
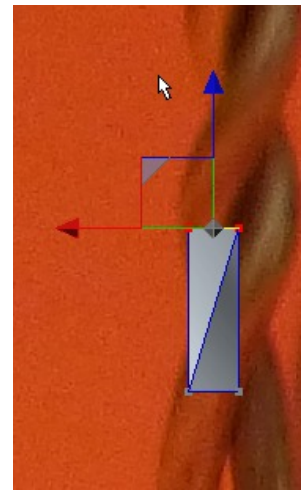
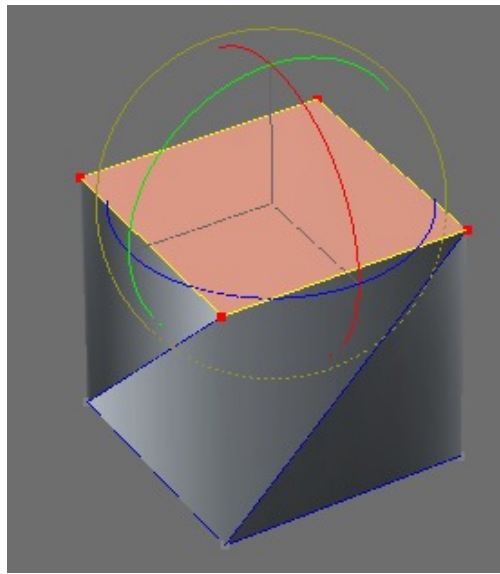
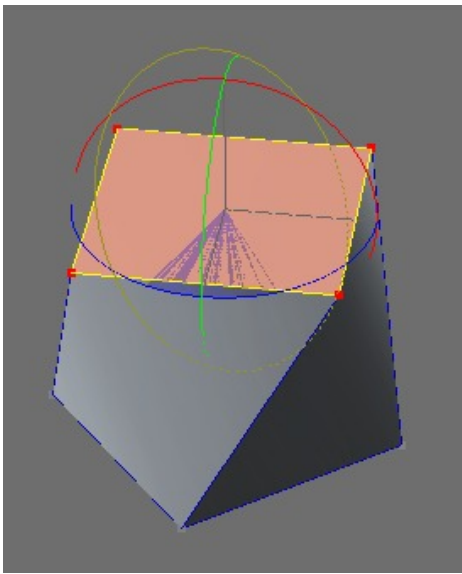

$$1,56 - 1,37 = 0,19$$

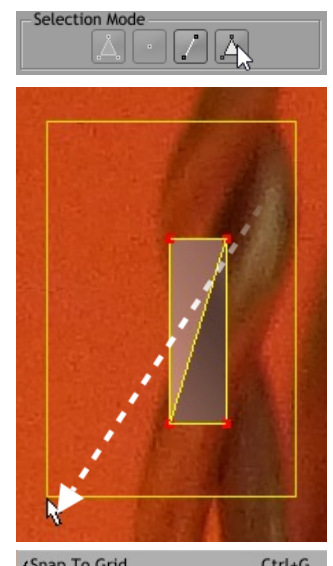
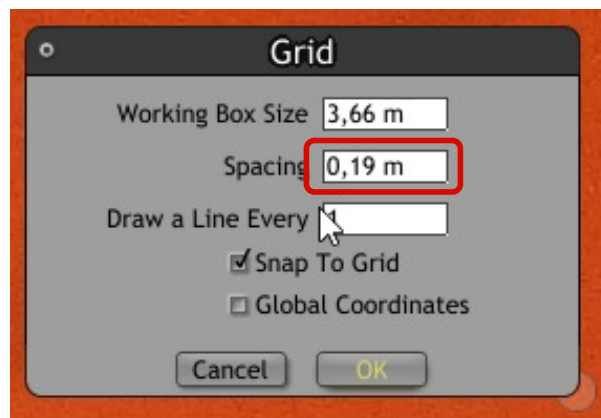
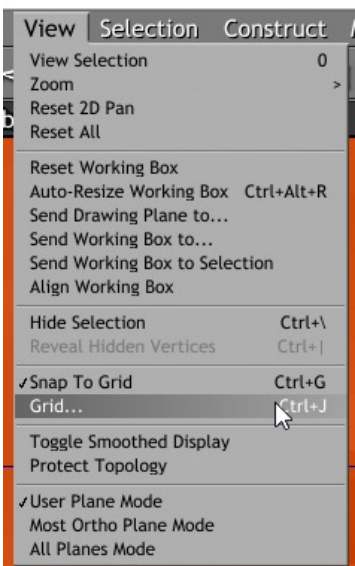

CTRL D (duplicate)
And move

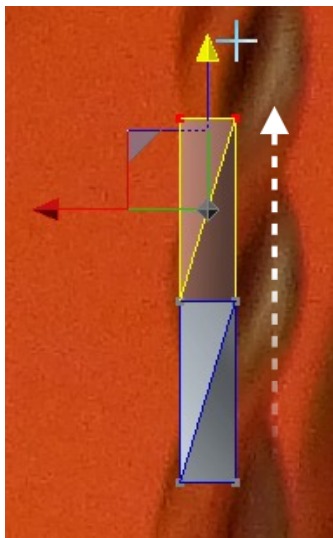

x 9

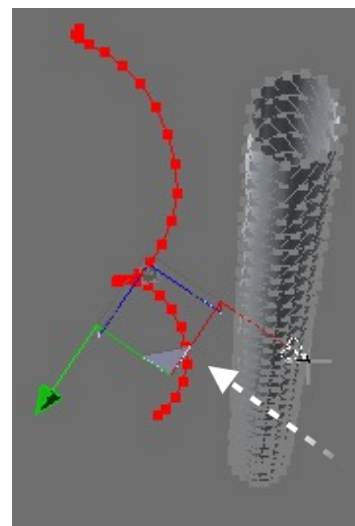
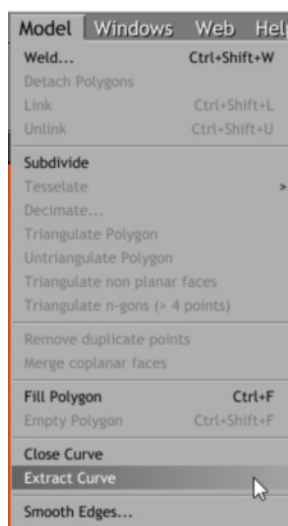
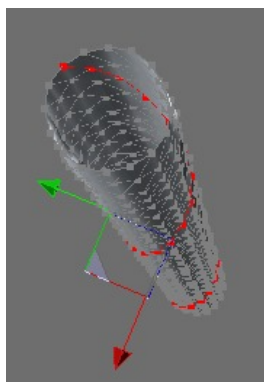
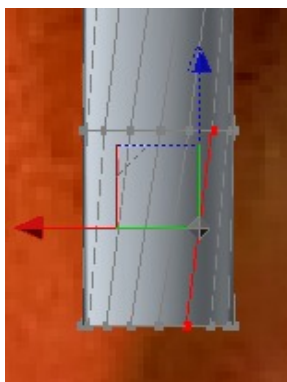
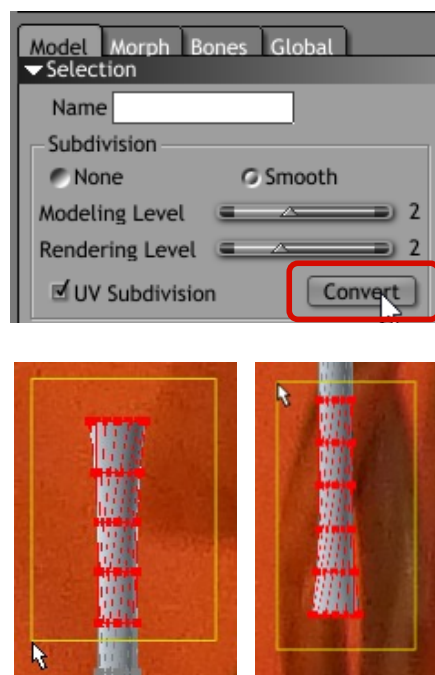
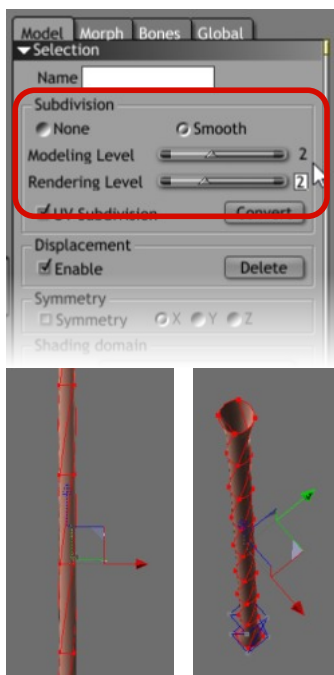
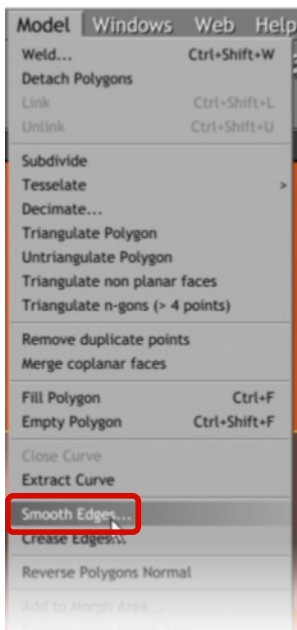
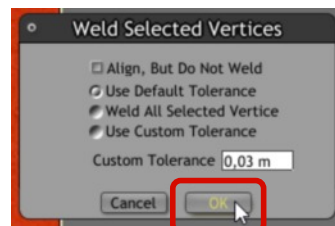
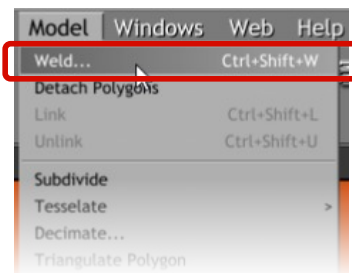
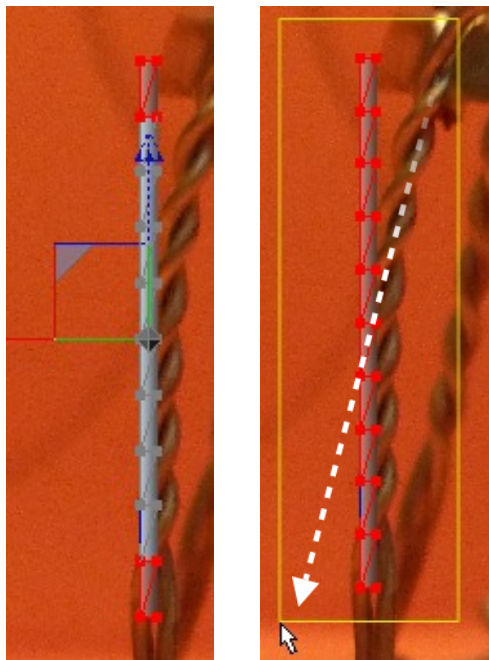

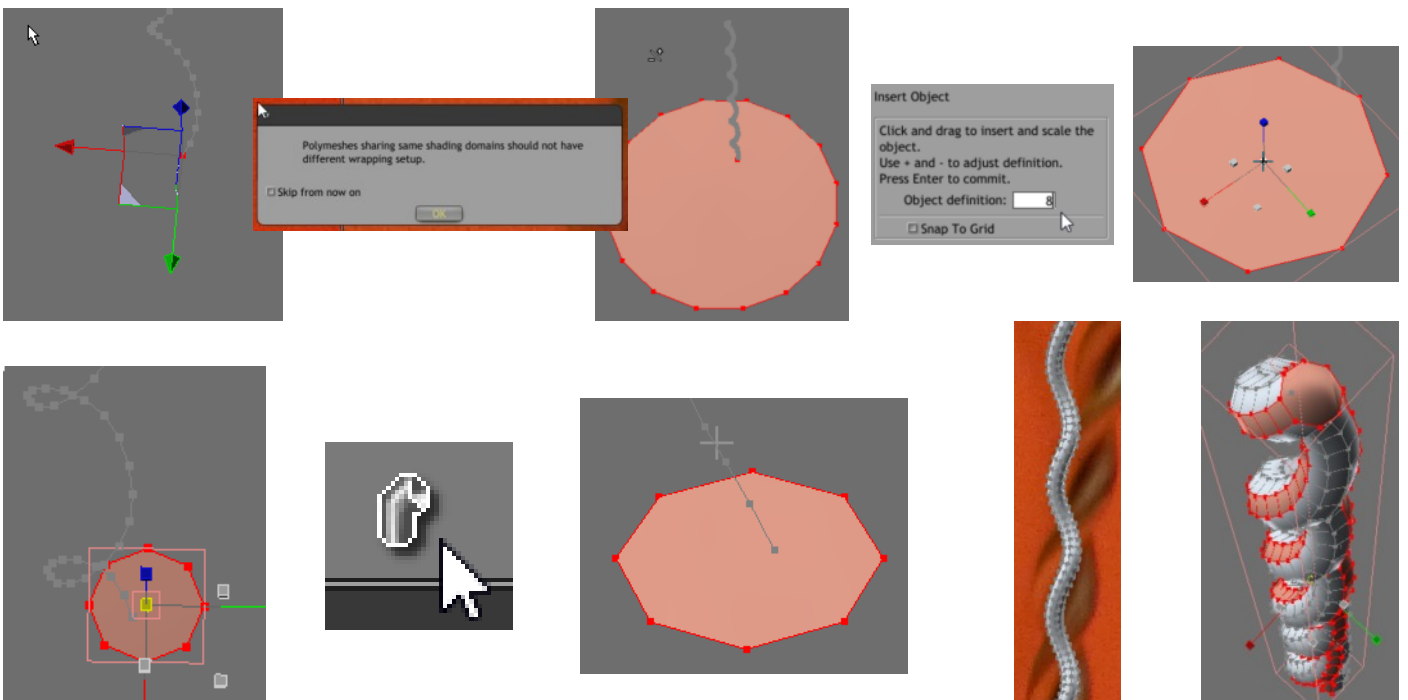
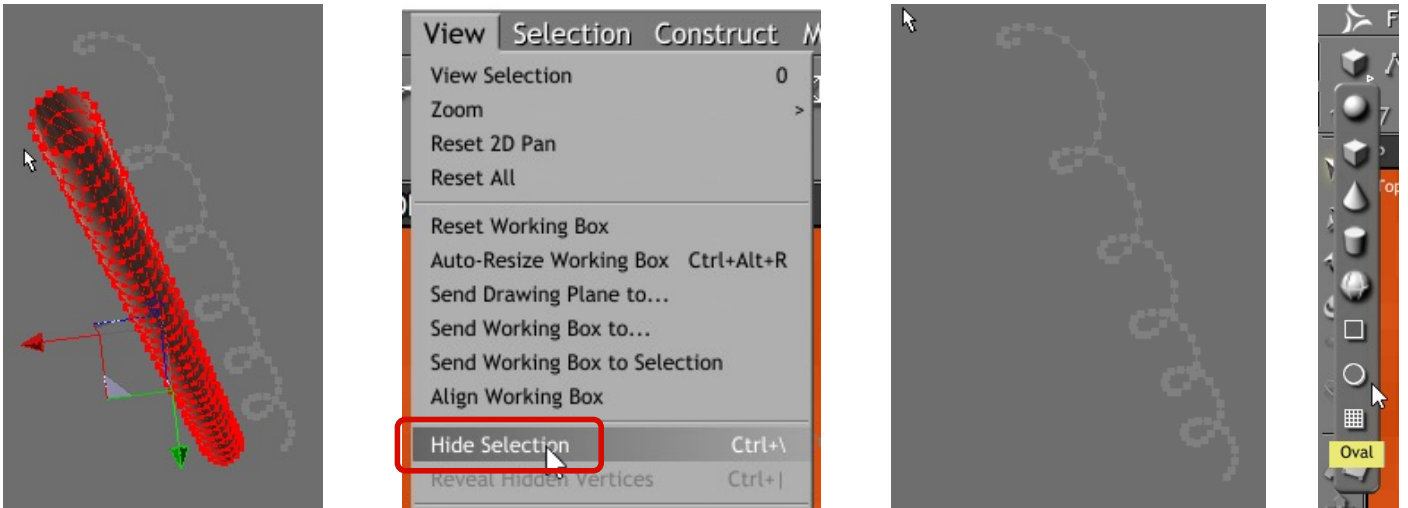
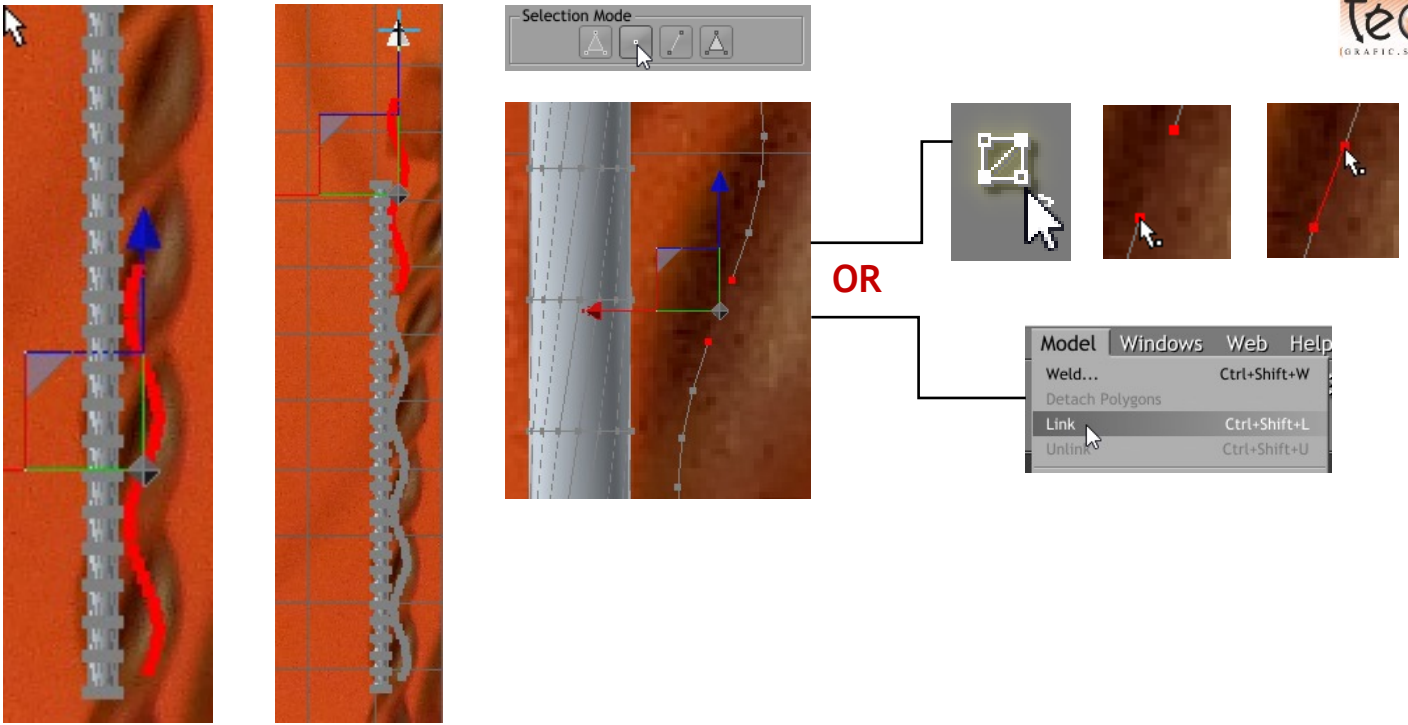

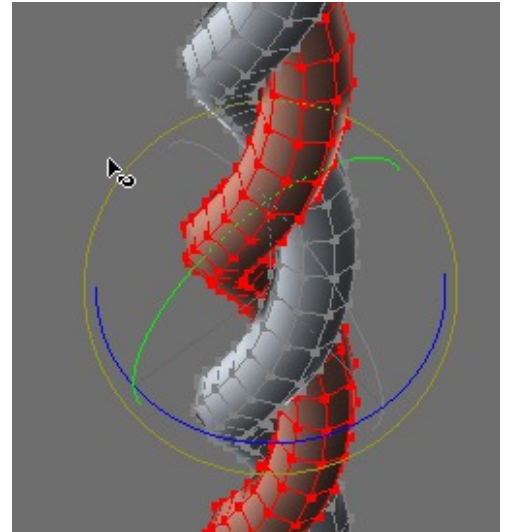
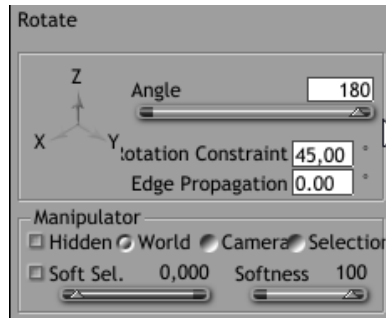
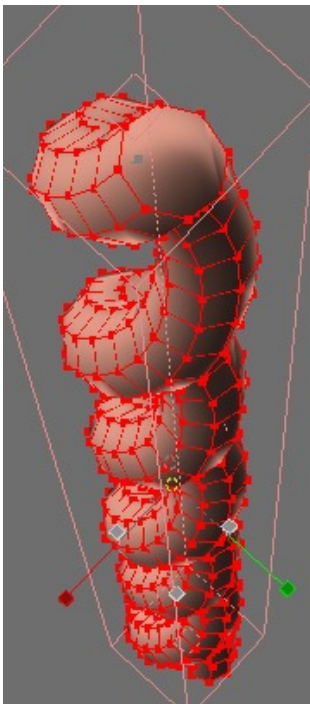

CTRL D (duplicate)
And rotate

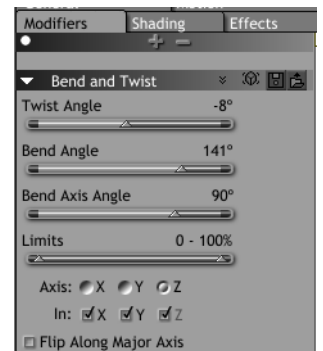
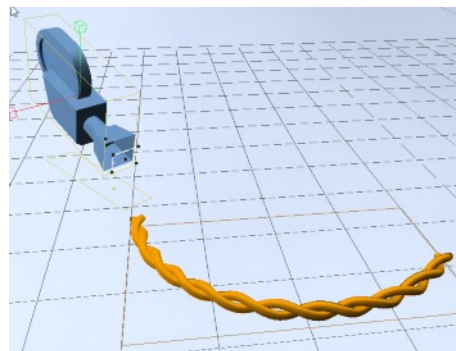
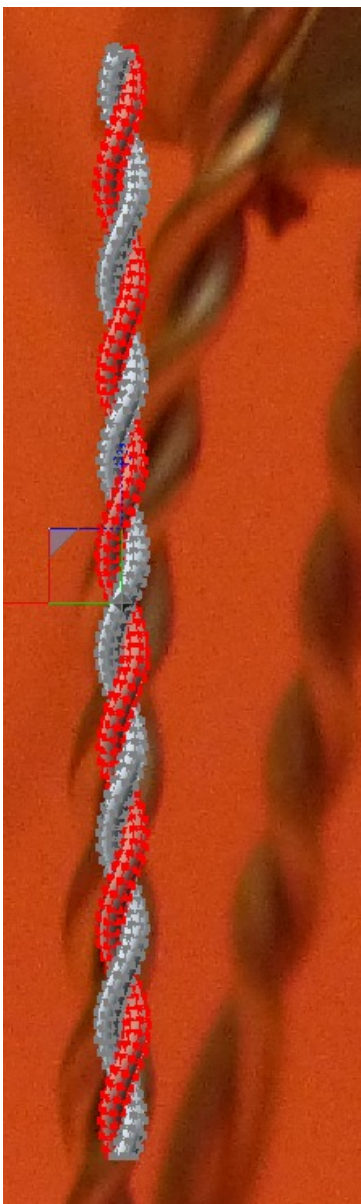

www.createo.fr

